

# PRODUCT CATALOG

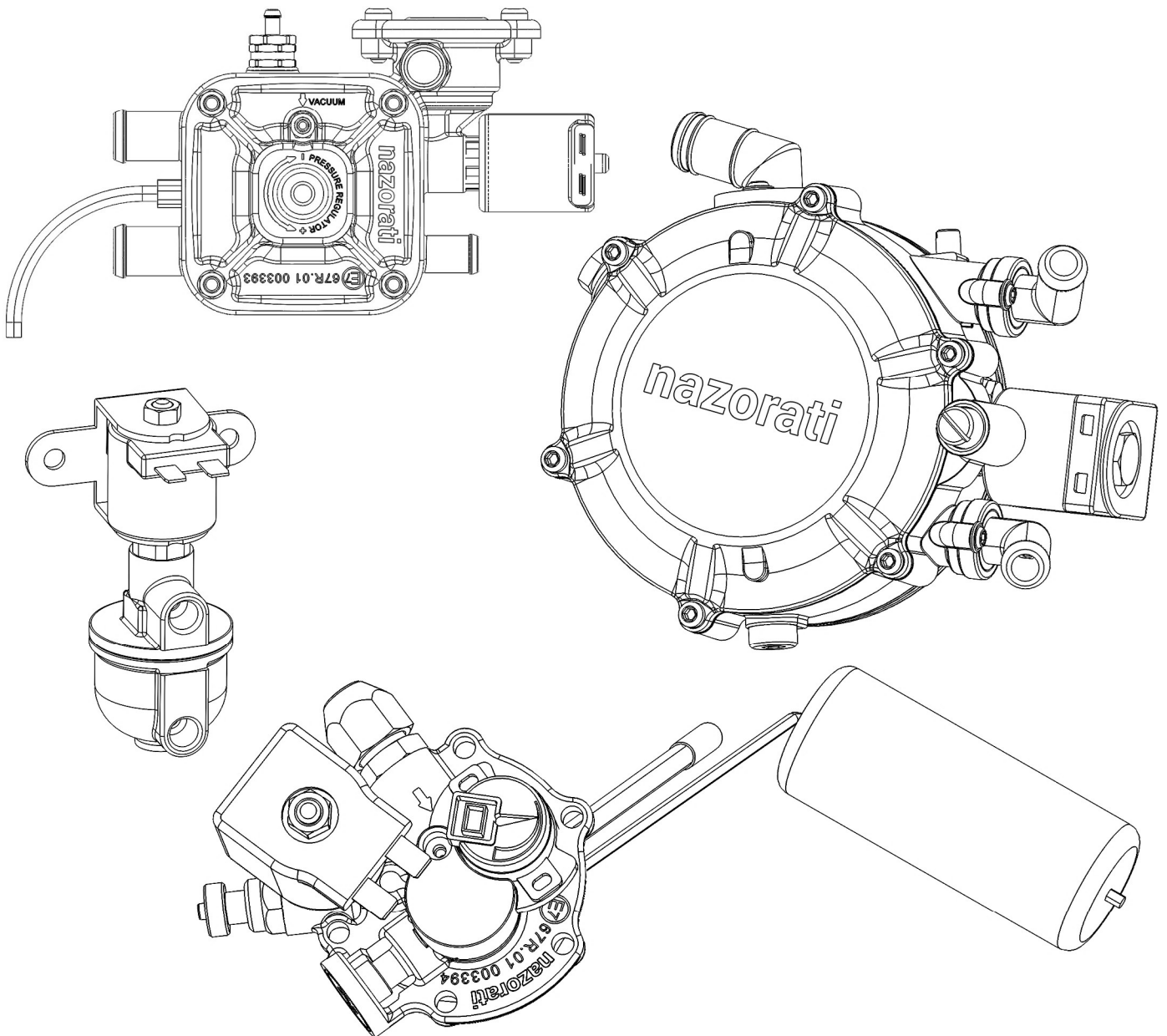

Nazorati is a manufacturer and worldwide supplier of autogas conversion equipment with 22 years of experience in the industry. The company is based in Istanbul, Turkiye.

We offer our clients a wide range of individual components as well as complete systems for carburetor, indirect or direct injection engines. Our main expertise is the production of mechanical components, such as reducers, multivalves, solenoid valves, etc. We use state-of-the-art computerized machines throughout the production process with the help of our experienced and hardworking employees. Designing and producing high quality items is our primary goal in the business.

We cooperate with two world-famous Italian companies for the supply of electronic controllers for sequential injection systems: AEB and Autronic. Both companies offer technologically the most advanced and innovative solutions to autogas market. Nazorati is the exclusive distributor of AEB Electronics for Turkiye.

Nazorati products are presented to our customers after various functioning tests and quality inspections, in accordance with the European Regulation of ECE-R 67.01, and therefore, recognized among our customers as reliable and extremely cost effective solutions. It is possible to find our products in 35 countries through a distribution network of importers, dealers and installers.

The following principles are the guidelines of our company: working hard for continuous improvement, updating R&D operations with the latest technology, investing in the business which we specialize in. We believe that we have a responsibility towards nature, and by producing environmentally friendly components, we try to make a contribution to the efforts for protecting the environment.



## NAZORATI LPG CONVERSION KITS

for  
**Carburetor,  
Single-Point Injection,  
Indirect Injection,  
Direct Injection engines.**





## DIRECT INJECTION KITS



Nazorati direct injection kits contain the last generation lpg system dedicated for the conversion of vehicles equipped with direct petrol injection engines.

“Di60” and “Di108” electronic control units that are produced by the Italian company AEB Electronics offer the possibility to convert a wide range of vehicles with 3/4/5/6/8-cylinder TSI, FSI, TFSI, GDI, TGI engines.

Nazorati direct injection system offers an excellent engine performance with minimized petrol consumption and subsequent emissions.

Direct injection kits are presented with AEB i-Plus lpg injectors to ensure precise gas dosage to the engine.



## INDIRECT INJECTION KITS



Nazorati indirect injection kits are dedicated to operate on all vehicles with 4th generation sequential injection engines. The vehicles are fueled with lpg, while maintaining the exhaust emission values at the same level with the original standards of the vehicle.

AEB injection systems are fully compatible with all types of sequential, semi-sequential, full-group engines from 3 to 8 cylinders.

Mechanical components of the kits are designed and produced by Nazorati with the latest technology. All components of the system are perfectly compatible with each other, and offer the best price/performance ratio in comparison to other systems.



## INDIRECT INJECTION KITS

# *ultima*

by



Nazorati indirect injection kits are dedicated to operate on all vehicles with 4th generation sequential injection engines. The vehicles are fueled with lpg, while maintaining the exhaust emission values at the same level with the original standards of the vehicle.

ULTIMA injection systems are designed and produced in Italy, and they are fully compatible with all types of sequential, semi-sequential, full-group engines from 3 to 8 cylinders.

Mechanical components of the kits are designed and produced by Nazorati with the latest technology. All components of the system are perfectly compatible with each other, and offer the best price/performance ratio in comparison to other systems.

## TRADITIONAL KITS



Nazorati traditional kits are dedicated for the conversion of vehicles with old type carburetor, single point or multi-point injection engines. These first representatives of autogas systems have begun to lose their popularity gradually with the increasing use of sequential injection engines in automotive industry since mid-nineties. However, traditional systems are still used in some countries today.

Application of traditional system kits is much more simple in comparison to new generation systems, but they are not as efficient as modern systems in terms of performance; nevertheless they still remain attractive for some users compared to price.

Nazorati traditional system kits operate with high performance in all weather and road conditions.





# LPG COMPONENTS



## LPG TRADITIONAL REDUCER

CM01-1000  
 RG1 Lpg Electronic Reducer  
 CM01-1100  
 RG1 Lpg Electronic Reducer Super



## LPG TRADITIONAL REDUCER

CM01-2000  
 RG2 Lpg Vacuum Reducer  
 CM01-2100  
 RG2 Lpg Vacuum Reducer Super



## LPG INJECTION REDUCER

CM01-3000  
 RG3 Atlas Lpg Injection Reducer  
 CM01-3100  
 RG3 Atlas Super Lpg Injection Reducer



## LPG INJECTION REDUCER

CM01-3200  
 RG3 Atlas Super Plus Lpg Injection Reducer

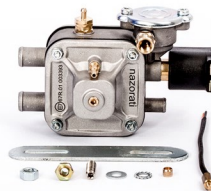

## LPG INJECTION REDUCER

CM01-4000  
 RG4 Atom Lpg Injection Reducer

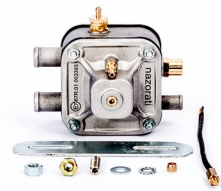

## LPG INJECTION REDUCER

CM01-5000  
 RG5 Atom XS Lpg Injection Reducer



## LPG MULTIVALVE

CM02-4000  
 MV5 Titan Lpg Multivalve  
 CM02-4100  
 MV5 Titan Extra Lpg Multivalve (Ø8mm)



## LPG MULTIVALVE

CM02-4200  
 MV5 Titan Special Lpg Multivalve  
 CM02-4300  
 MV5 Titan Special Extra Lpg Multivalve (Ø8mm)



## ULTIMA SEQUENTIAL INJECTION ECU KITS

CM03-1000 / Ultima Basic Ecu Kit 4 Cyl  
 CM03-1100 / Ultima Ecu Kit 4 Cyl  
 CM03-1200 / Ultima Ecu Kit 4 Cyl Obd  
 CM03-1300 / Ultima Ecu Kit 6 Cyl Obd  
 CM03-1400 / Ultima Ecu Kit 8 Cyl Obd



## ULTIMA DIRECT INJECTION ECU KITS

CM03-2000  
 Ultime DGI Ecu Kit 4 Cyl Obd



## AEB SEQUENTIAL INJECTION ECU KITS

CM03-3000 / MP32 Ecu Kit 4 Cyl  
 CM03-3100 / MP48 Ecu Kit 4 Cyl  
 CM03-3200 / MP48OBD Ecu Kit 4 Cyl Obd  
 CM03-3300 / MP6C Ecu Kit 6 Cyl Obd  
 CM03-3400 / AEB2568 Ecu Kit 6/8 Cyl Obd



## AEB DIRECT INJECTION ECU KITS

CM03-4000 / Di60 Ecu Kit 4 Cyl Obd  
 CM03-4100 / Di60NG Ecu Kit 4 Cyl Obd  
 CM03-4200 / Di108 Ecu Kit 6/8 Cyl Obd

## LPG COMPONENTS

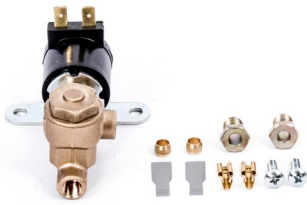

### LPG SOLENOID VALVE

CM04-1000  
SV1 Lpg Solenoid Valve  
With Big Coil



### LPG SOLENOID VALVE

CM04-1100  
SV1 Lpg Solenoid Valve  
With Small Coil



### LPG SOLENOID VALVE

CM04-2000  
SV2 Lpg Solenoid Valve

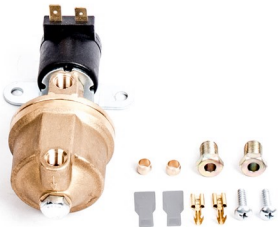

### LPG SOLENOID VALVE

CM04-3000  
SV3 Lpg Solenoid Valve



### LPG SOLENOID VALVE

CM04-3100  
SV3 Extra Lpg Solenoid Valve  
Ø8 mm Gas Inlet/Outlet



### LPG SOLENOID VALVE

CM04-4000  
SV7 Lpg Solenoid Valve

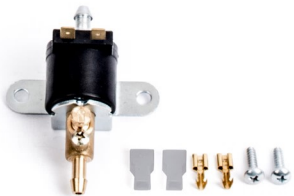

### PETROL SOLENOID VALVE

CM04-5000  
SV4 Petrol Solenoid Valve

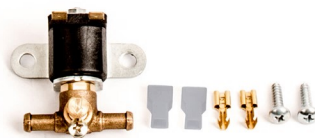

### PETROL SOLENOID VALVE

CM04-6000  
SV5 Petrol Solenoid Valve



### PETROL SOLENOID VALVE

CM04-7000  
SV6 Petrol Solenoid Valve



### LPG FILLING VALVE

CM05-1000 / FV1 Filling Valve with All Accessories  
CM05-1100 / FV1 Filling Valve with Mounting Bracket  
CM05-1200 / FV1 Filling Valve with Plastic Housing



### LPG FILLING VALVE

CM05-2000  
FV2 Filling Valve for Petrol Door  
With Short Adapter

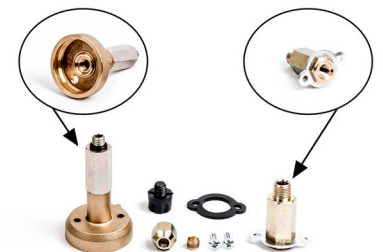

### LPG FILLING VALVE

CM05-2100  
FV2 Filling Valve for Petrol Door  
With Long Adapter



# LPG COMPONENTS



## LPG FILLING VALVE

CM05-3000  
FV4 ACME Filling Valve



## LPG FILLING VALVE

CM05-4000  
FV4 ACME Filling Valve for Petrol Door  
With Short Adapter



## LPG FILLING VALVE

CM05-4100  
FV4 ACME Filling Valve for Petrol Door  
With Long Adapter



## LPG FILLING VALVE

CM05-5000  
FV5 Thermoplastic Filling Valve



## LPG FILLING VALVE

CM05-6000  
FV5 Thermoplastic Filling Valve for Petrol Door  
With Short Adapter



## LPG FILLING VALVE

CM05-6100  
FV5 Thermoplastic Filling Valve for Petrol Door  
With Long Adapter



## LPG/CNG INJECTOR RAIL

CM06-1000 / Nazorati Injector 4 Cyl  
CM06-1100 / Nazorati Injector 3 Cyl  
CM06-1200 / Nazorati Injector 2 Cyl



## LPG/CNG INJECTOR RAIL

CM06-2000  
AEB i-Plus Injector 4 Cyl  
CM06-2100  
AEB i-Plus Injector 3 Cyl



## FUEL SWITCH FOR TRADITIONAL SYSTEMS

CM07-1000 / Carburetor Switch 1050 Type (30K-0 Ω)  
CM07-1100 / Carburetor Switch 1090 Type (0-90 Ω)  
CM07-2000 / Injection Switch 1050 Type (30K-0 Ω)  
CM07-2100 / Injection Switch 1090 Type (0-90 Ω)



## FUEL SWITCH FOR TRADITIONAL SYSTEMS

CM07-3000  
Vacuum Switch



## FUEL SWITCH FOR SEQUENTIAL SYSTEMS

CM07-4000  
Switch for ULTIMA Injection Systems  
CM07-5000  
Switch for AEB Injection Systems



## INJECTOR EMULATOR

CM08-1000 / Injector Emulator 4 Cyl  
CM08-1100 / Injector Emulator 6 Cyl  
CM08-1200 / Injector Emulator 8 Cyl

## ACCESSORIES



### FUEL LEVEL INDICATOR

AC01-1000 / Level Sensor 1050 Type (30K-0 Ω)  
AC01-1100 / Level Sensor 1090 Type (0-90 Ω)  
AC01-1200 / Level Sensor 1110 Type (110-0 Ω)



### ULTIMA MAP SENSOR

AC02-1000  
Ultima Map Sensor

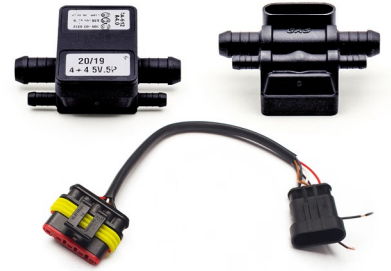

### ULTIMA MAP SENSOR

AC02-1100  
Ultima P+T Map Sensor  
With Adapter Cable



### AEB MAP SENSOR

AC02-1200  
AEB 025 Map Sensor



### AEB MAP SENSOR

AC02-1300  
AEB P+T Map Sensor



### TEMPERATURE SENSOR

AC02-2000  
Temperature Sensor for Reducer M5  
4,7kOhm



### TEMPERATURE SENSOR

AC02-2100  
Temperature Sensor for Injector M12x1  
4,7kOhm



### RELAY

AC03-1000  
Petrol Pump Timer Relay 30A

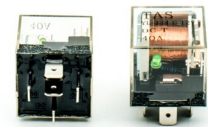

### RELAY

AC03-1100  
Relay 12V 40A 5-pin



### MULTIVALVE HOUSING

AC04-1000  
Gas Tight Housing for Cylindrical MV  
Type A



### MULTIVALVE HOUSING

AC04-1100  
Gas Tight Housing for Cylindrical MV  
Type B



### MULTIVALVE HOUSING

AC04-1200  
Protector Cover for External Toroidal MV



# ACCESSORIES



## TANK MOUNTING STRAPS

AC04-3000 / Tank Straps 20 x 980 mm  
 AC04-3100 / Tank Straps 20 x 1200 mm  
 AC04-3200 / Tank Straps 30 x 1000 mm  
 AC04-3300 / Tank Straps 30 x 1300 mm



## TANK MOUNTING FRAME

AC04-4000 / Tank Mounting Frame 46 cm  
 AC04-4100 / Tank Mounting Frame 56 cm  
 AC04-4200 / Tank Mounting Frame 66 cm  
 AC04-4300 / Tank Mounting Frame 80 cm  
 AC04-4400 / Tank Mounting Frame 90 cm



## ECU

AC05-1XXX / Ecu Only for Ultima SGI System  
 AC05-2XXX / Ecu Only for Ultima DI System  
 AC05-3XXX / Ecu Only for AEB SGI System  
 AC05-4XXX / Ecu Only for AEB DI System



## WIRING HARNESS

AC06-1XXX / Harness for Ultima SGI System  
 AC06-2XXX / Harness for Ultima DI System  
 AC06-3XXX / Harness for AEB SGI System  
 AC06-4XXX / Harness for AEB DI System



## USB INTERFACE CABLE

AC06-5000  
 Ultima USB Interface Cable



## USB INTERFACE CABLE

AC06-5100  
 AEB USB Interface Cable



## OBD SCAN TOOL

AC07-1000  
 AEB 214 Plus OBD Tester



## MOUNTING ACCESSORIES

AC08-1000  
 Mounting Accessories for Traditional Kits



## MOUNTING ACCESSORIES

AC08-2XXX  
 Mounting Accessories for Sequential Kits  
 For 4/6/8 Cyl Kits



## RUBBER HOSES

AC09-1000 / 4x9 mm Lpg Hose  
 AC09-1100 / 6x12 mm Lpg/Petrol Hose  
 AC09-1200 / 12x19 mm Lpg Hose  
 AC09-1300 / 19x26 mm Lpg Hose  
 AC09-1400 / 16x23 mm Water Hose



## LPG PIPE LINE

AC09-2000  
 6 mm Copper Pipe  
 AC09-2100  
 8 mm Copper Pipe



## LUBRICATOR BOTTLE

AC10-1000  
 Valve Saver Bottle

## SPARE PARTS



### REDUCER REPAIR KIT

SP01-1000  
Repair Kit for RG1 Electronic Reducer



### REDUCER REPAIR KIT

SP01-1100  
Repair Kit for RG2 Vacuum Reducer



### REDUCER REPAIR KIT

SP01-2000  
Repair Kit for RG3 Atlas Reducer



### REDUCER REPAIR KIT

SP01-3000  
Repair Kit for RG4 Atom Reducer



### REDUCER REPAIR KIT

SP01-4000  
Repair Kit for RG5 Atom XS Reducer



### SOLENOID COIL

SP02-1000  
Coil Set for RG1 Reducer



### SOLENOID COIL

SP02-1200  
Starter Coil for RG2 Reducer



### SOLENOID COIL

SP02-2000  
Coil Set for Sequential Reducers 17W



### SOLENOID COIL

SP02-3000  
Coil Set for Multivalves 11W



### SOLENOID COIL

SP02-4000  
Coil Set for Lpg Valves Medium Size



### SOLENOID COIL

SP02-5000  
Coil Set for Lpg/Petrol Valves Small Size



### INJECTOR REPAIR KIT

SP02-6100  
Repair Kit for Injector (Turkish)  
SP02-6200  
Repair Kit for Injector (Italian)



## SPARE PARTS



### INJECTOR REPAIR KIT

SP02-6300  
Plunger Set for Injector (Turkish)  
SP02-6400  
Plunger Set for Injector (Italian)



### INJECTOR REPAIR KIT

SP02-7000  
Repair Kit for AEB Injector



### GAS FILTER

SP03-1000  
Vapor Filter 12x12 mm



### GAS FILTER

SP03-1100  
Vapor Filter 12x12x12 mm



### GAS FILTER

SP03-2000  
Filter for SV1 Solenoid Valve



### GAS FILTER

SP03-2100  
Filter for SV2 Solenoid Valve



### GAS FILTER

SP03-2200  
Filter for SV3 Solenoid Valve



### GAS FILTER

SP03-2300  
Filter for SV7 Solenoid Valve



### GAS FILTER

SP03-3000  
Filter for RG3 ATLAS Reducer



### GAS FILTER

SP03-3100  
Filter for RG4 ATOM Reducer



### GAS FILTER

SP03-4000  
Filter for Multivalve Fuel Pipe dia.6 mm  
SP03-4100  
Filter for Multivalve Fuel Pipe dia.8 mm



### WATER/GAS ELBOW

SP04-1000  
Plastic Water Elbow for Reducer dia.16 mm

## SPARE PARTS



### WATER/GAS ELBOW

SP04-1100  
Plastic Gas Elbow for Reducer dia.19 mm



### WATER/GAS ELBOW

SP04-1200  
Metal Gas Elbow for Reducer dia.12 mm



### VACUUM NOZZLE

SP04-1300  
Vacuum Nozzle for Injection Reducers



### RESSURE RELIEF VALVE

SP04-1400  
Pressure Relief Valve for Injection Reducers



### ADJUSTER SCREW

SP04-2000  
Gas Adjuster Screw for Traditional Reducers

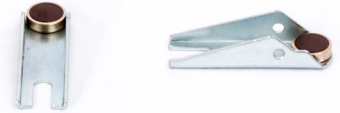

### REDUCER CUT-OFF LEVER

SP04-3000  
1st Stage Lever for Traditional Reducers



### REDUCER CUT-OFF LEVER

SP04-3100  
2nd Stage Lever for Traditional Reducers



### REDUCER CUT-OFF LEVER

SP04-3200  
Atom Injection Reducer Lever



### MULTIVALVE FLOAT

SP05-1000  
NBR Multivalve Float



### MANUAL VALVE

SP05-2000  
Multivalve Manual Valve Big  
SP05-2100  
Multivalve Manual Valve Small



### MULTIVALVE GASKET

SP05-3000  
Multivalve Gasket



### FILLING VALVE CAP

SP05-4000  
Cap for FV1 Filling Valve



## SPARE PARTS



### FILLING VALVE CAP

SP05-4100  
Cap for FV2 Filling Valve



### FILLING VALVE CAP

SP05-4200  
Cap for ACME Type Filling Valve



### FILLING VALVE ADAPTER

SP05-5000  
Short Adapter for FV2 Filling Valve 54 mm  
SP05-5100  
Long Adapter for FV2 Filling Valve 88 mm



### FILLING VALVE ADAPTER

SP05-5200  
Short Adapter for ACME Type Filling Valve 58 mm  
SP05-5300  
Long Adapter for ACME Type Filling Valve 115 mm



### EXTENSION FOR FILLING VALVE ADAPTER

SP05-5400  
Extension Piece for Adapter 43 mm



### MOUNTING BRACKET

SP05-6000 / Filling Valve Mounting Bracket 108 mm  
SP05-6100 / Filling Valve Mounting Bracket 152 mm  
SP05-6200 / Filling Valve Mounting Bracket 200 mm



### GAS ADJUSTER

SP06-1000 / Plastic Gas Adjuster 19x12 mm  
SP06-1100 / Plastic Gas Adjuster 19x19 mm  
SP06-1200 / Plastic Gas Adjuster 19x12x12 mm



### GAS ADJUSTER

SP06-2000 / Metal Gas Adjuster 16x16 mm  
SP06-2100 / Metal Gas Adjuster 19x12 mm  
SP06-2200 / Metal Gas Adjuster 19x19 mm  
SP06-2300 / Metal Gas Adjuster 19x12x12 mm

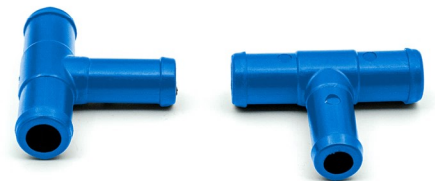

### T CONNECTION

SP06-3000 / Plastic T Connection 16x16x16 mm  
SP06-3100 / Plastic T Connection 19x19x16 mm  
SP06-3200 / Plastic T Connection 5x5x5 mm



### T CONNECTION

SP06-4000  
Metal T Connection 19x19x16 mm



### INJECTOR FITTINGS

SP07-1000  
Injector Nozzle 6 mm



### INJECTOR FITTINGS

SP07-1100  
Manifold Nozzle M6 / 6 mm  
SP07-1200  
Manifold Nozzle M6 / 4,5 mm

## SPARE PARTS



### INJECTOR FITTINGS

SP07-1300  
Vacuum Hose Connector M12 / 4,5 mm



### INJECTOR FITTINGS

SP07-1400  
Gas Inlet Fitting for Injector dia. 12 mm



### INJECTOR FITTINGS

SP07-1600  
Blanking Plug for Injector



### INJECTOR FITTINGS

SP07-2000 / AEB Injector Nozzle 6 mm  
Red - Ø1,6 mm / Yellow - Ø1,8 mm  
Green - Ø2,0 mm / Black - Ø2,2 mm



### CONNECTION FITTINGS

SP07-3000  
Ø6 mm Copper Pipe Nut (Male)



### CONNECTION FITTINGS

SP07-3100  
Ø8 mm Copper Pipe Nut (Male)



### CONNECTION FITTINGS

SP07-3200  
Ø8 mm Copper Pipe Nut (Female)



### CONNECTION FITTINGS

SP07-3300  
Ø8 mm Thermoplastic Pipe Nut (Female)



### CONNECTION FITTINGS

SP07-3400  
Ø6 mm Copper Pipe Ring



### CONNECTION FITTINGS

SP07-3500  
Ø8 mm Copper Pipe Ring



### CONNECTION FITTINGS

SP07-3700  
Ø8 mm Thermoplastic Pipe Ring



### CONNECTION FITTINGS

SP07-3800  
6x6 mm Nipple Connector  
SP07-3900  
6x8 mm Nipple Connector



## SPARE PARTS



### CONNECTION FITTINGS

SP07-4100 / 6x6 mm Copper Pipe Connector  
 SP07-4200 / 8x8 mm Copper Pipe Connector  
 SP07-4300 / 6x8 mm Copper Pipe Connector



### CONNECTION FITTINGS

SP07-5000  
 Thermoplastic Pipe Straight Connector  
 6 mm Input / 8 mm Output



### CONNECTION FITTINGS

SP07-5100  
 Thermoplastic Pipe Straight Connector  
 8 mm Input / 8 mm Output



### CONNECTION FITTINGS

SP07-5200  
 Thermoplastic Pipe Straight Fitting M10x1  
 6 mm Input / 8 mm Output



### CONNECTION FITTINGS

SP07-5300  
 Thermoplastic Pipe Straight Fitting M12x1  
 8 mm Input / 8 mm Output



### CONNECTION FITTINGS

SP07-5400  
 Thermoplastic Pipe Fitting for Multivalve  
 8 mm Output



### CONNECTION FITTINGS

SP07-5500  
 Thermoplastic Pipe Fitting for Filling Valve  
 8 mm Output



### CONNECTION FITTINGS

SP07-5600  
 Thermoplastic Pipe Elbow Fitting M10x1  
 6 mm Input / 8 mm Output



### CONNECTION FITTINGS

SP07-5700  
 Thermoplastic Pipe Elbow Fitting M12x1  
 8 mm Input / 8 mm Output



### CONNECTION FITTINGS

SP07-5800  
 Thermoplastic Pipe Elbow Connector  
 6 mm Input / 8 mm Output



### CONNECTION FITTINGS

SP07-5900  
 Thermoplastic Pipe Elbow Connector  
 8 mm Input / 8 mm Output



### INSULATION TAPE

SP08-2000  
 Insulation Tape



**NAZORATI MÜHENDİSLİK VE MAKİNA SAN. TİC. LTD. ŞTİ.**

Dudullu OSB Mah. DES Sanayi Sitesi, 111. Sokak,

D19 Blok, No: 19-21, Ümraniye - İSTANBUL

Tel: +90-216-6601192 Fax: +90-216-6601193 info@nazorati.com